

## SPECIFICATIONS

### ELECTRICAL

Current dissipation : 55 mA(Colored:35mA)  
 Power Consumption : 0.66 W(Colored:0.42W)  
 Operating power : DC 12V  
 Maximum serial connection : 50 modules  
 Electronic dimming control supported

### THERMAL

Cooling : Ambient air  
 Maximum operating temperature : 40°C  
 Minimum operating temperature : -20°C  
 Maximum storage temperature : 60°C  
 Minimum storage temperature : -30 C



42,500H LIFETIME

IP65

DC12V



### PHYSICAL

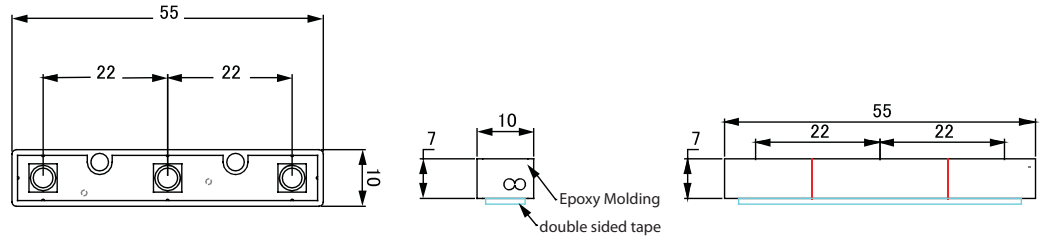

## PRECAUTIONS



Use precautions to avoid damages to the product or injuries of users. Any actions against following contents will cause serious issues such as malfunction, electric shock, or burn.

**DC12V** USE DC12V ONLY

**AC INPUT** DO NOT USE AC INPUT



Do not cut or rejoin wires while product is connected with live power source



Avoid performing installation under rain or high humidity for outdoor use



Do not use the product under circumstances listed below

- High temperature spots over 60°C (140°F)
- Spots draw extreme moisture or dust
- Spots have corrosive gas or highly effected by electromagnetic field



Do not perform actions listed below

- Alter or modify
- Touch LED lamps with sharp objects
- Put glue or silicon over the LED lamps



Maximum driver quantity per serial connection is limited. Failure causes overload of current and damages to the product



Refer to 'WIRE THICKNESS' table to use proper wire thickness between SMPS and the first LED module  
 Failure will cause dimmed output



Cable length between SMPS and the first LED module is limited. Refer to 'CONNECTION WITH POWER SUPPLY' on page 2

## PREPARATION

### TOOLS REQUIRED

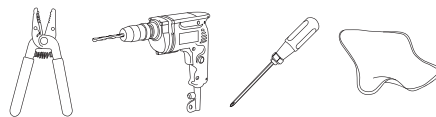

Wire Stripper, Drill, Screw Driver, Wiper

### SUPPLIES REQUIRED

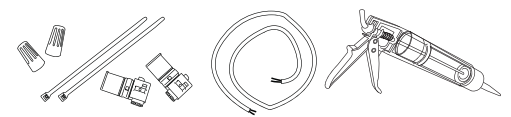

Wire Nuts, Cable Ties, IDC Connectors, VCTF(PLTC) Cable, (Optional : Silicon and Screws)

### PREPARE CHANNELS

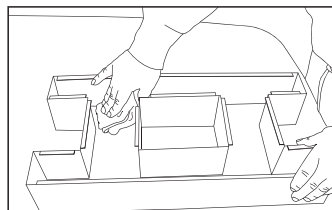

1. Clean moisture and dust inside

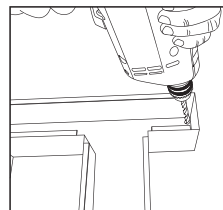

2. Make holes

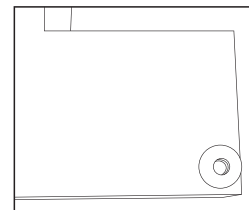

3. Use bushing to protect wires

1. Wipe out dust, water, and oil inside. 3M tape will come off easily if product is mounted on uncleaned surfaces.
2. Make holes for wires from modules to SMPS.
3. Without bushings, wires will easily be cut and short-circuit will occur.

\*Use white paint inside the channels for better reflection

## LAYOUT DENSITY GUIDELINES

Use recommended length for pitch between each module to achieve optimum lighting output while maintaining lowest unit cost. Failure or misplacing will cause dimmed spots or uneven appearance of light on the surface.

### RECOMMENDED PITCH PER DEPTH

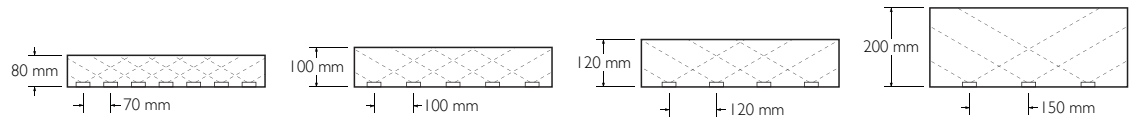

### RECOMMENDED LAYOUT DENSITY PER CHANNEL WIDTH

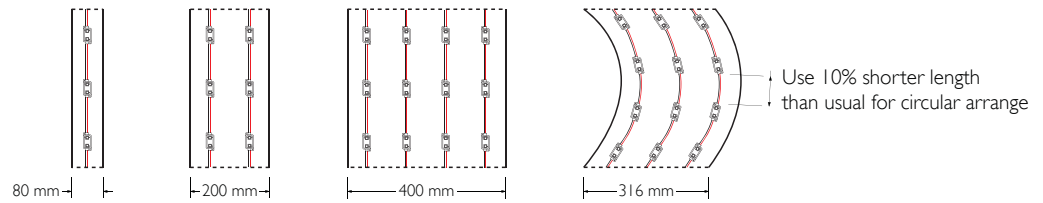

## CONNECTION GUIDE

Maximum driver quantity per serial connection is limited. Using more quantity per run will cause overload from SMPS which damages all connected products. This will cause voltage drop and also dimmed lighting output.

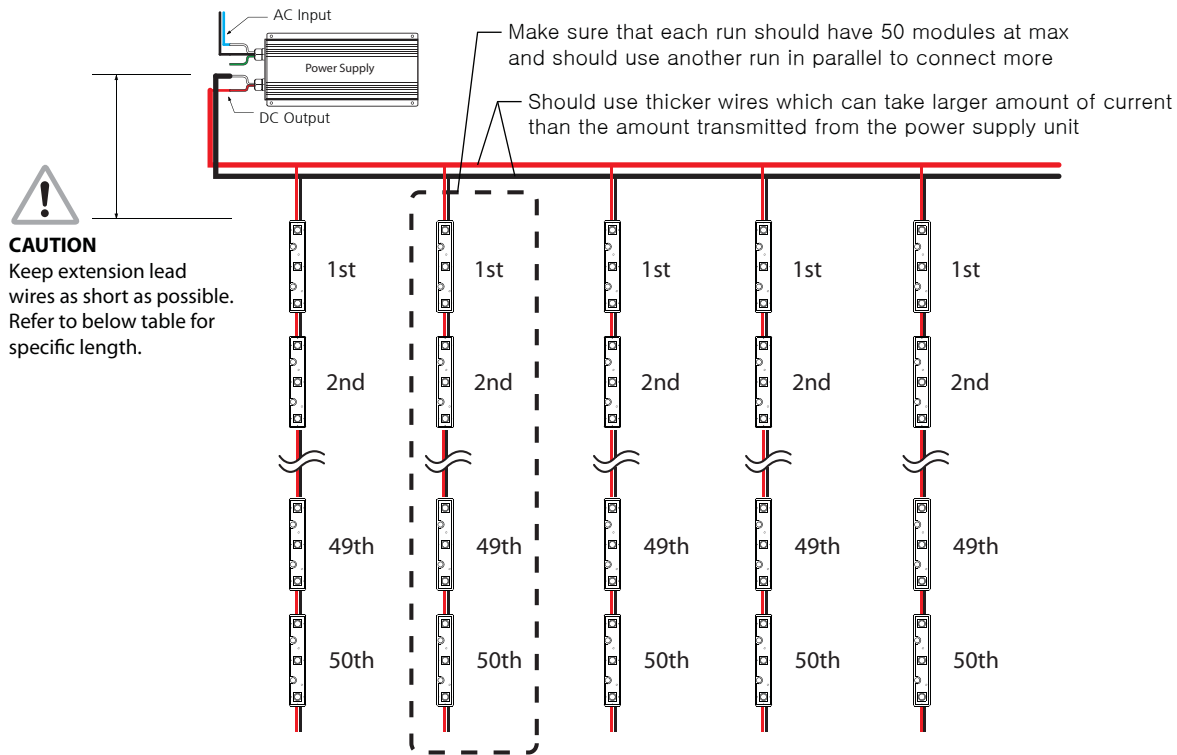

## CONNECTION WITH POWER SUPPLY

### EXTENSION OF POWER SUPPLY LEAD WIRES

Model Name	PSCS-0030-12	PSCS-0060-12	PSCS-0120-12	PSCS-0600-12**	PSCS-1000-12**
Output (W)	30W	60W	120W	600W	1000W
Output (A)	2.5A	5A	10A	50A	83A
Max Q'TY - White*	40pcs	78pcs	155pcs	780pcs	1300pcs
Max Q'TY - Colors*	60pcs	120pcs	240pcs	1200pcs	2000pcs
Recommended Extension Wire	VCTF1.25 AWG18	VCTF2.0 AWG14	VCTF2.0 AWG12	VCTF5.5 AWG4	VCTF8.0 AWG2
Maximum Length	5M (15FT)	5M (15FT)	5M (15FT)	15M (50FT)	15M (50FT)

\*Maximum quantity for S-LED is based on 85% of specified capacity of power supplies for extended lifespan

\*\*PSCS-0600-12, PSCS-1000-12 are not weather-proof

Equip with protective box for outdoor use and the box should have ventilating holes

## INSTALLATION GUIDE

### 1. DETERMINE LAYOUT

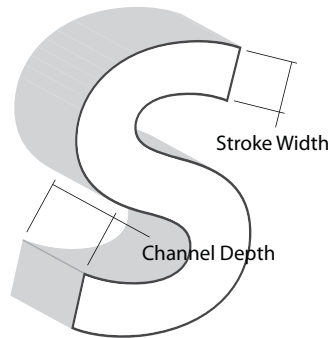

Refer to 'LAYOUT DENSITY GUIDELINES' on page 2 to determine spacing and amount of LEDs required.

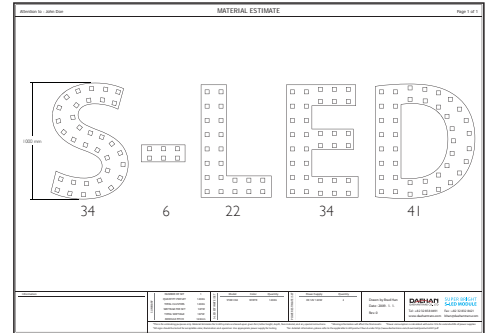

**SUPPORTS FOR OUR SIGNMATES**  
Ask us to obtain accurate layout

### 2. PEEL AND STICK

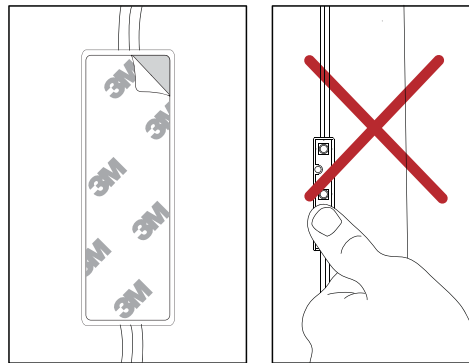

Using predetermined layout and LED placement from step 1, remove 3M tape on the back of modules and stick them into place. Ensure modules are firmly attached on the surface.



**CAUTION**

When handling the module, avoid pressing down directly on top of LED lamp

### 3. CAP ALL UNUSED WIRES

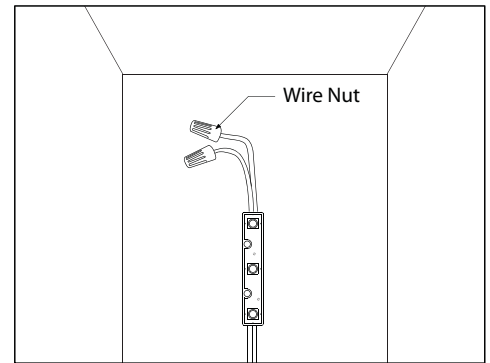

The strand of modules should not be looped to create a closed circuit.

### 4. POWER UP AND TEST

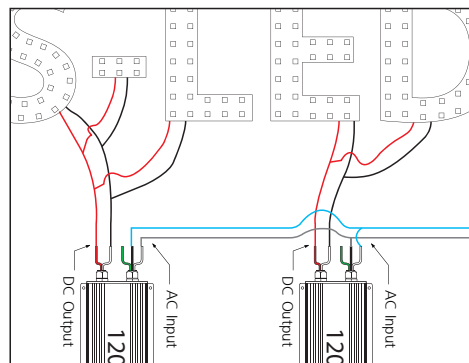

Using predetermined layout and LED placement from step 1, divide channels into sections and distribute each section to corresponding power supplies.



**CAUTION**

Before connect with power supplies, check polarity on every connections

### 5. FIX MODULES PERMANENTLY

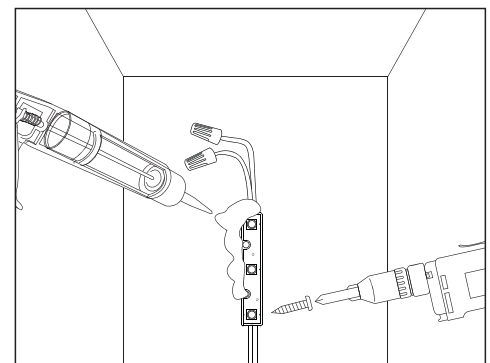

**FASTENERS** : If desired, modules can be secured with M2.5\*15 metal screws.

**SILICON** : If desired, modules can be secured with silicon. Do not to put silicon on the top of the LED lamps.

### TROUBLE SHOOTING

Entire sign or leg does not light after complete installation.	Check connection from power supply lead to first module. Make sure polarity of connections made at the power supply lead and any jumper wire is correct. Power supply outputs should be connected red-to-red and white-to-white.
Still does not light.	Check output voltage of power supply using a voltmeter. The output voltage should be 12.0VDC $\pm$ 0.5VDC. If there is no output voltage, have a licensed electrician check input voltage. Make sure power supply is connected correctly and getting primary power. Probably AC input wire is connected to ground terminal of power supply. If power supply is connected properly and getting primary power and there is still no output voltage, try a different power supply.
Still does not light.	If power supply is getting primary power and the modules do not light, there may be a short in the secondary wiring. Check all connections and cap all loose wires.
Beginning of a leg lights, but the entire leg does not light or lights intermittently.	The primary cause of a portion of a S-LED leg not lighting or lighting intermittently is a bad connection or reverse polarity connection between the modules that light and the modules that don't light. Check this connection.
One module does not light, but all others in the leg light.	S-LED is designed so if one module fails, it will not cause the entire sign or leg to go out. If one module does not light, but all others in the leg do, replace this module with a new one.
All modules light, but some of them are dimmed.	Check each run has no more than maximum number of modules. Also ensure that type of the extension wire from SMPS to the first module is correct. If wires are not thick enough to transmit current from SMPS, this will cause voltage drop and will dim the modules at the end.
Dark spots or dimmed spots occur.	Channel depth is too low, or center distance between modules is too far. Refer to 'LAYOUT DENSITY GUIDELINES' for more information.
Still has spots.	Covering acrylic is not intended for LED illumination. Use light diffusing acrylic sheets which are specially made for LED light source.